

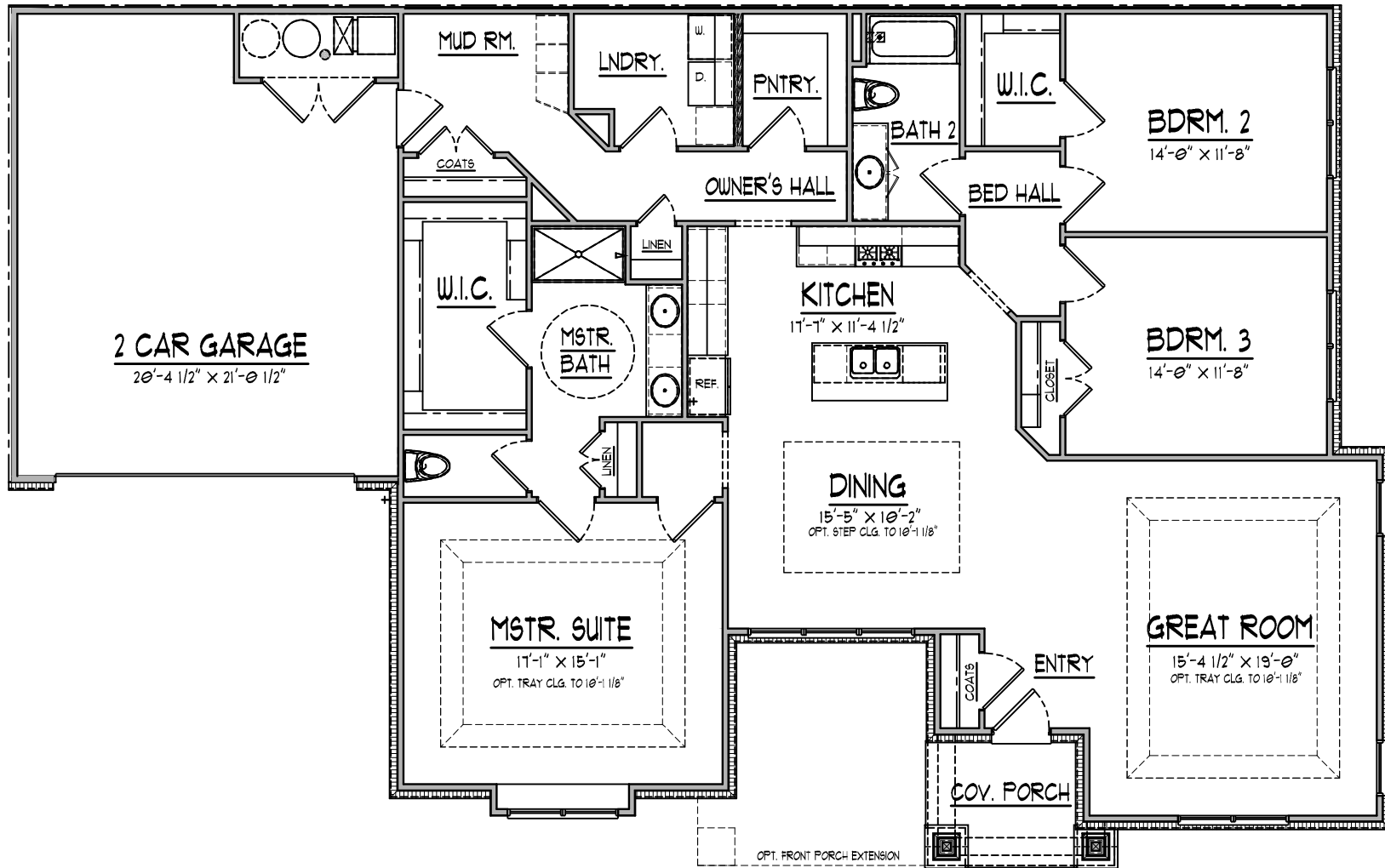

LINCOLN CRAFTSMAN ELEVATION

NOT TO SCALE



LINCOLN BROCHURE PLAN
NOT TO SCALE 2,066 SQ. FT. (FINISHED)

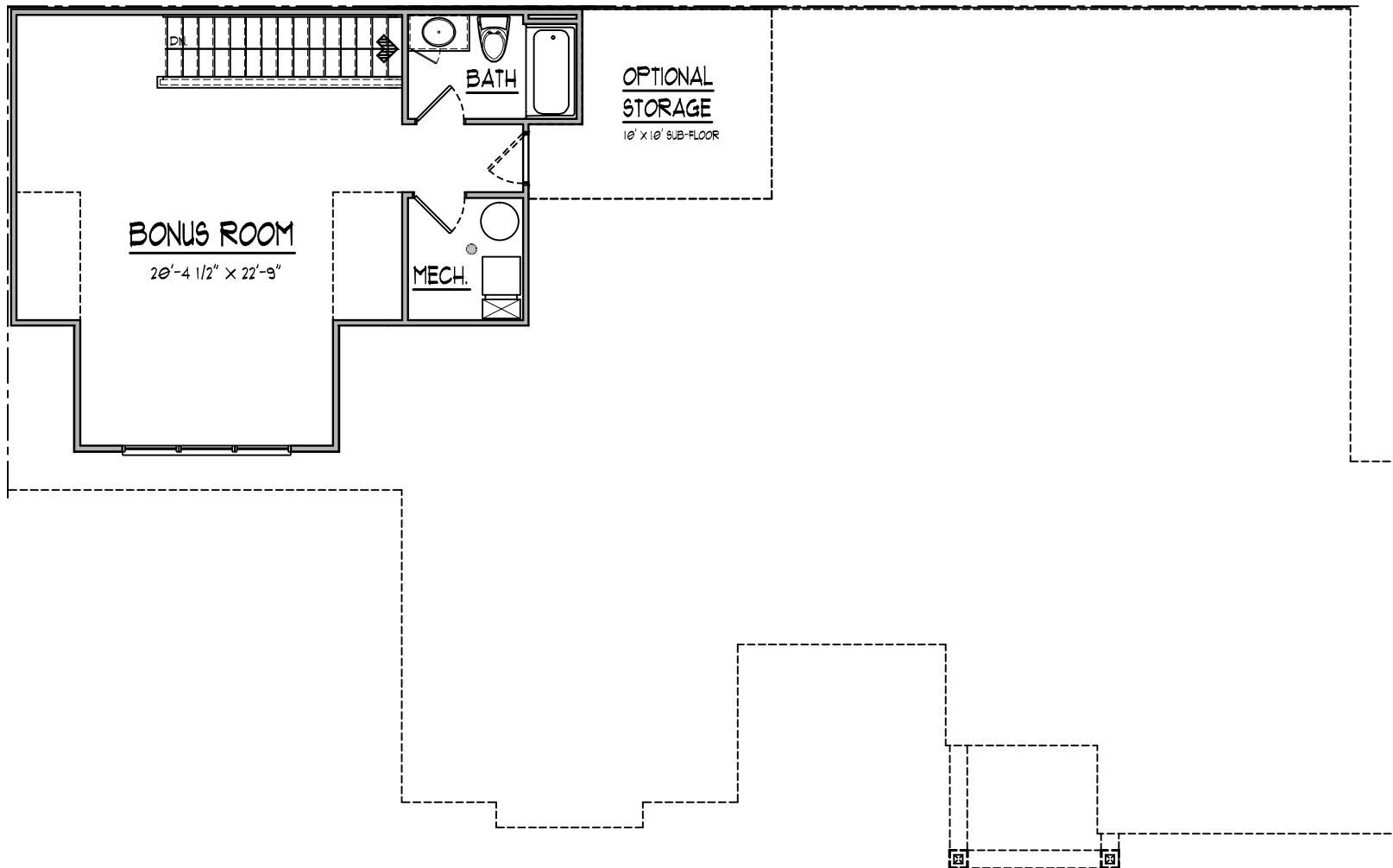

LINCOLN BROCHURE PLAN
OPTIONAL BONUS ROOM AND OPTIONAL FULL BATH
NOT TO SCALE 521 SQ. FT. (FINISHED)



OPTIONAL EXTENDED PORCH

NOT TO SCALE

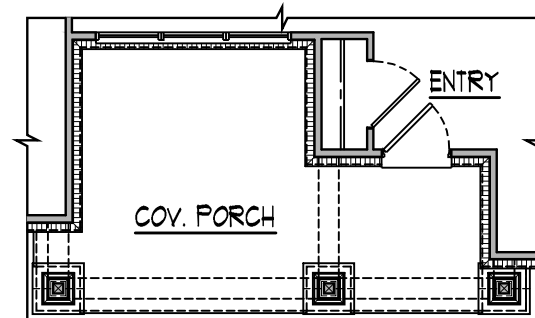

OPTIONAL EXTENDED PORCH

NOT TO SCALE

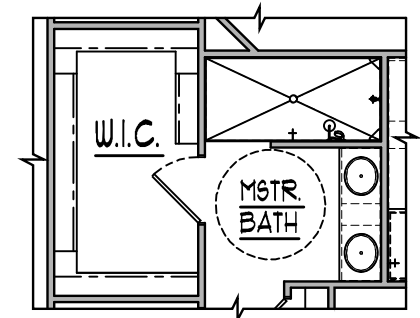

OPTIONAL ROLL-IN SHOWER

NOT TO SCALE

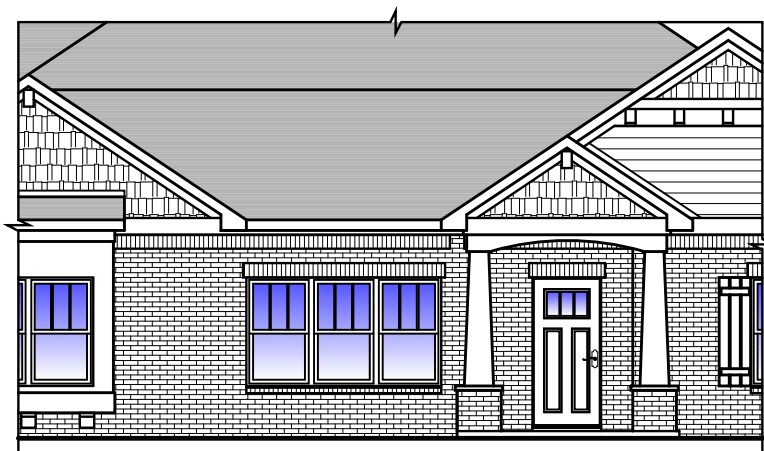

OPTIONAL SUNROOM

NOT TO SCALE

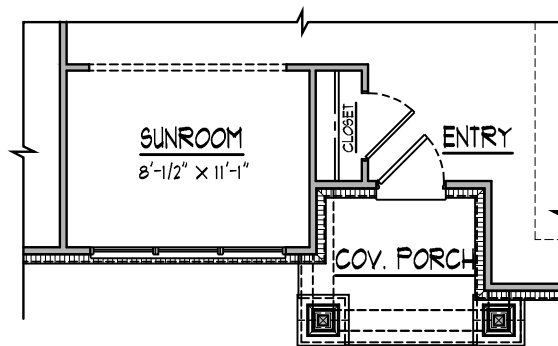

OPTIONAL SUNROOM

NOT TO SCALE

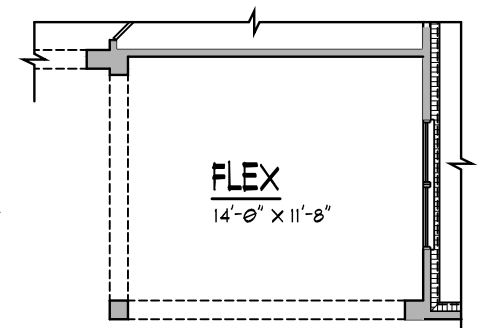

OPTIONAL FLEX ROOM

I.L.O. BEDROOM 3

NOT TO SCALE